



Stronger
Safer
Smarter!



Contents:

Meeting the Toughest Demands	03
Customer Portal	05
Temporary Fencing	06
Temporary Fence Gates	12
Temporary Fence Stillages	14
Temporary Hoarding	16
Temporary Hoarding Stillage	18
Temporary Hoarding Gates	19
Pedestrian Barriers	20
Pedestrian Barrier Gates	26
Pedestrian Barrier Stillages	27
Event Barrier Systems	28
Cycle Barrier	29
Police Barrier	30
Police Barriers Euro	31
Stabiliser Systems	32
Stabiliser Components	36
Accessories	38
Netting and Covers	45
Site Safety	46
Scaffold Products	47
Smartguard Trestle System	48
Print Services	50



Meeting the toughest demands

Innovative solutions from Europe's largest manufacturer of **temporary fencing** and **pedestrian barriers**.

ZND has 50 plus years of history in manufacturing, with plants in Holland, France, Poland and the UK. Our origins stem from wire drawing and mesh manufacturing, but in the last 25 years we have built a solid reputation across Europe as the market leader in the manufacturing and supply of high quality temporary fencing, hoarding and pedestrian barriers.

Our UK operation was opened in 1997, and has developed into a high tech manufacturing facility, where innovation is at the core of our business. With substantial investment we developed and then automated the production of the now well known SmartWeld temporary fencing system which has become the markets preferred choice product.

We create the strongest, safest and smartest products on the market by continuously investing in new and improved manufacturing techniques, better and more rigorous testing and a firm commitment to research design and development.

Our commitment to UK manufacturing enables us to maintain high quality and fast delivery when you need it most.

Customer Portal

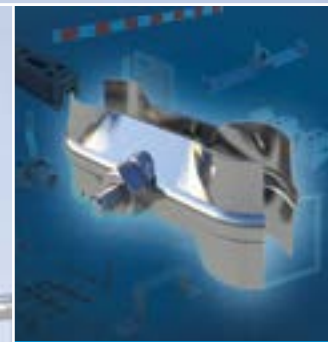
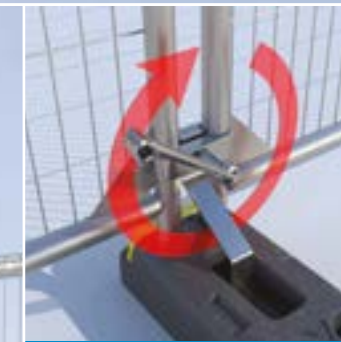
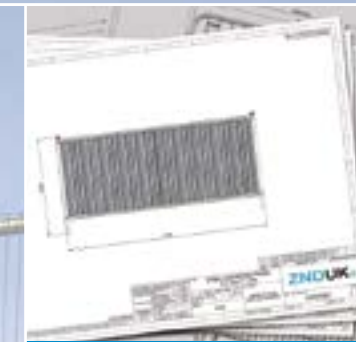

Photo and Illustration library for your promotions



Assembly guides



Technical drawings

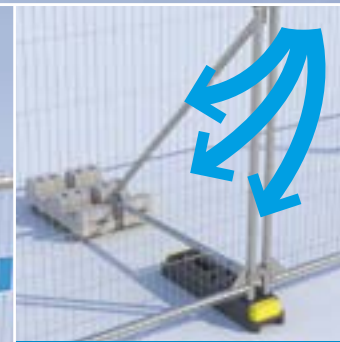

Calculate your required stabilisation

Our customers get access to our **free online Customer Portal** giving you all the after sales support that you need.

Our Customer Portal offers you

Windspeed Calculator

Use our handy windspeed calculation tool to work out what stabilisation is needed for all our fence and hoarding panels. You can even find out real time windspeed information, request bespoke calculations and download PDF files.

Assembly guides

Find out how to assemble and install our fences and hoarding in the safest way. Download our easy to understand assembly guides with your own branding.

Technical drawings

Download technical drawings of all our products with dimensions, pitch and wire diameters. You can even place your own branding on the drawings for your own use.

Photo and Illustration library

Download high resolution photos and illustrations of all our products to use in your own promotions.

For access to the Customer Portal* go to www.znduk.com/customerportal and login or set up an account.

*Setting up an account will require ZND approval.



All our documents can be downloaded pre-branded with your **company's logo** and are ready to use!





Temporary Fencing

- ST25
- ST30
- ST38
- RT38

Modular mesh temporary fencing has proved to be extremely popular with our customers in the construction and event management industries for site demarcation and to direct the public away from construction hazards or towards secure areas.

Since 1997 we have specialised in the manufacturing and continual development of SmartWeld™ temporary fencing, creating a comprehensive range of panels, designed and manufactured to a high standard.

All our temporary fencing panels are manufactured in our highly efficient, state of the art manufacturing facility in the UK, where we are able to produce more than 8000 fences a day in over 30 different specifications.

We offer a wide variety of specification options with a choice of:

- Frame styles
- Mesh types
- Wire diameters
- Corporate identity labels
- Surface finishes

We offer a comprehensive range of panels, manufactured to the highest possible standards, made to order and delivered directly to your site so you can be confident that we can meet all site situations and local health and safety requirements.

We have an extensive range of accessories to complement our panel systems including:

- Thermo-plastic and concrete bases
- Standard and lockable fence couplers
- Pedestrian and vehicle gates
- Height extension panels
- Stabilising systems



All our temporary fences can be powder coated in a colour of your choice



Many of ZND's products are protected by patents which can be found at www.znduk.com/patents

Fence Panel Ranges

Our fence panels are split into two different series: the Square Top (ST) and the Round Top (RT).

Examples		
Product Range	Mesh Type	Options
ST30	Standard	CP
RT38	Anticlimb	3V
ST30	Euro	220

1 Frame Styles

ST



RT



ST25:

Horizontal Tube Diameter: 25mm
Vertical Tube Diameter: 38mm

ST30:

Horizontal Tube Diameter: 30mm
Vertical Tube Diameter: 40mm

ST38:

Horizontal Tube Diameter: 38mm
Vertical Tube Diameter: 38mm

RT38:

Horizontal Tube Diameter: 38mm
Vertical Tube Diameter: 38mm

2 Mesh Types

Standard



Vertical Pitch: 100mm
Vertical Wire Diameter: ø2.2
Horizontal Pitch: 262mm
Horizontal Wire Diameter: ø3.2

Euro



Vertical Pitch: 100mm
Vertical Wire Diameter: ø3.2
Horizontal Pitch: 262mm
Horizontal Wire Diameter: ø3.2

Anticlimb



Vertical Pitch: 43mm
Vertical Wire Diameter: ø2.2
Horizontal Pitch: 262mm
Horizontal Wire Diameter: ø3.2

3 Options



Special Length

Some panels are available in differing lengths. We can also create bespoke special lengths for your requirements.



CP

Adding corner plates increases the strength of the panel joint where they are used.



3V

These options can add either a vertical or horizontal tube into the centre of the panel.

3H

Now you are ready to order your fence panel, pick a frame type, select which mesh you want and choose from the optional extras to improve the panel quality.

ST25

Our ST25 range has horizontal tube diameters of 25mm and vertical tube diameters of 38mm and is available in Standard and Anticlimb mesh with the option of corner plates.



Illustration shows ST25 Anticlimb CP

Frame	Dimension (mm)	Weight (kg)	Stock Code
ST25 Standard	3450 x 2025	11.2	05551731
ST25 Standard CP	3450 x 2025	11.7	05551831
ST25 Anticlimb	3450 x 2025	13.6	06552031
ST25 Anticlimb CP	3450 x 2025	14.1	06552331

Please refer to the guide on page 7 for more information on fence types.

ST30

Our ST30 range has horizontal tube diameters of 30mm and vertical tube diameters of 40mm and is available in Euro and Anticlimb mesh with the option of corner plates and additional vertical or horizontal centre tubes.



Illustration shows ST30 Euro CP 3H

Frame	Dimension (mm)	Weight (kg)	Stock Code
ST30 Euro (Barrier)	3452 x 1200	10.8	02061031
ST30 Euro	3452 x 2025	15	07061051
ST30 Euro CP	3452 x 2025	15.5	07061055
ST30 Euro 3V	3452 x 2025	16.5	07061057
ST30 Euro CP 3V	3452 x 2025	17	07061058
ST30 Euro 3H	3452 x 2025	17.4	07061061
ST30 Euro CP 3H	3452 x 2025	17.9	07061068
ST30 Anticlimb	3452 x 2025	15.4	07061071
ST30 Anticlimb CP	3452 x 2025	15.9	07061072
ST30 Anticlimb 3V	3452 x 2025	16.9	07061073
ST30 Anticlimb CP 3V	3452 x 2025	17.4	07061074
ST30 Anticlimb 3H	3452 x 2025	17.8	07061075
ST30 Anticlimb CP 3H	3452 x 2025	18.3	07061076
ST30 Euro 220	2195 x 2025	11.2	07061031
ST30 Euro 220 CP	2195 x 2025	11.7	07061035
ST30 Euro 220 3H	2195 x 2025	12.7	07061041
ST30 Euro 220 CP 3H	2195 x 2025	13.2	07061045

Please refer to the guide on page 7 for more information on fence types.

ST38

Our ST38 range has horizontal and vertical tube diameters of 38mm and is available in Standard and Anticlimb mesh with the options of corner plates and additional horizontal or vertical centre tubes.



Illustration shows ST38 Anticlimb CP 3H

Frame	Dimension (mm)	Weight (kg)	Stock Code
ST38 Standard	3450 x 2025	13.4	05552731
ST38 Standard CP	3450 x 2025	13.9	05552741
ST38 Anticlimb	3450 x 2025	15.8	07052031
ST38 Anticlimb CP	3450 x 2025	16.3	07052032
ST38 Anticlimb CP 3V	3450 x 2025	17.9	07056031
ST38 Anticlimb CP 3H	3450 x 2025	19.4	07056041
ST38 Anticlimb 285	2850 x 2025	13.6	07052033

Please refer to the guide on page 7 for more information on fence types.

RT38

Our RT38 range has horizontal and vertical tube diameters of 38mm and is available in Standard, Euro and Anticlimb mesh with the option of adding additional horizontal or vertical centre tubes. Corner plates are fitted throughout the RT38 range.



Illustration shows RT38 Anticlimb 3V

Frame	Dimension (mm)	Weight (kg)	Stock Code
RT38 Standard	3450 x 2000	13.4	05553731
RT38 Standard 3V	3450 x 2000	15	05553741
RT38 Standard 3H	3450 x 2000	16.5	05554031
RT38 Euro	3450 x 2000	15.4	07061079
RT38 Euro 3V	3450 x 2000	17	07061080
RT38 Euro 3H	3450 x 2000	18.4	07061085
RT38 Anticlimb	3450 x 2000	15.9	07052232
RT38 Anticlimb 3V	3450 x 2000	17.5	07052332
RT38 Anticlimb 3H	3450 x 2000	19	07052432
RT38 Anticlimb 175	1750 x 2000	9.7	07052234

Please refer to the guide on page 7 for more information on fence types.

Temporary Fences: Gates



Temporary Fences: Gates

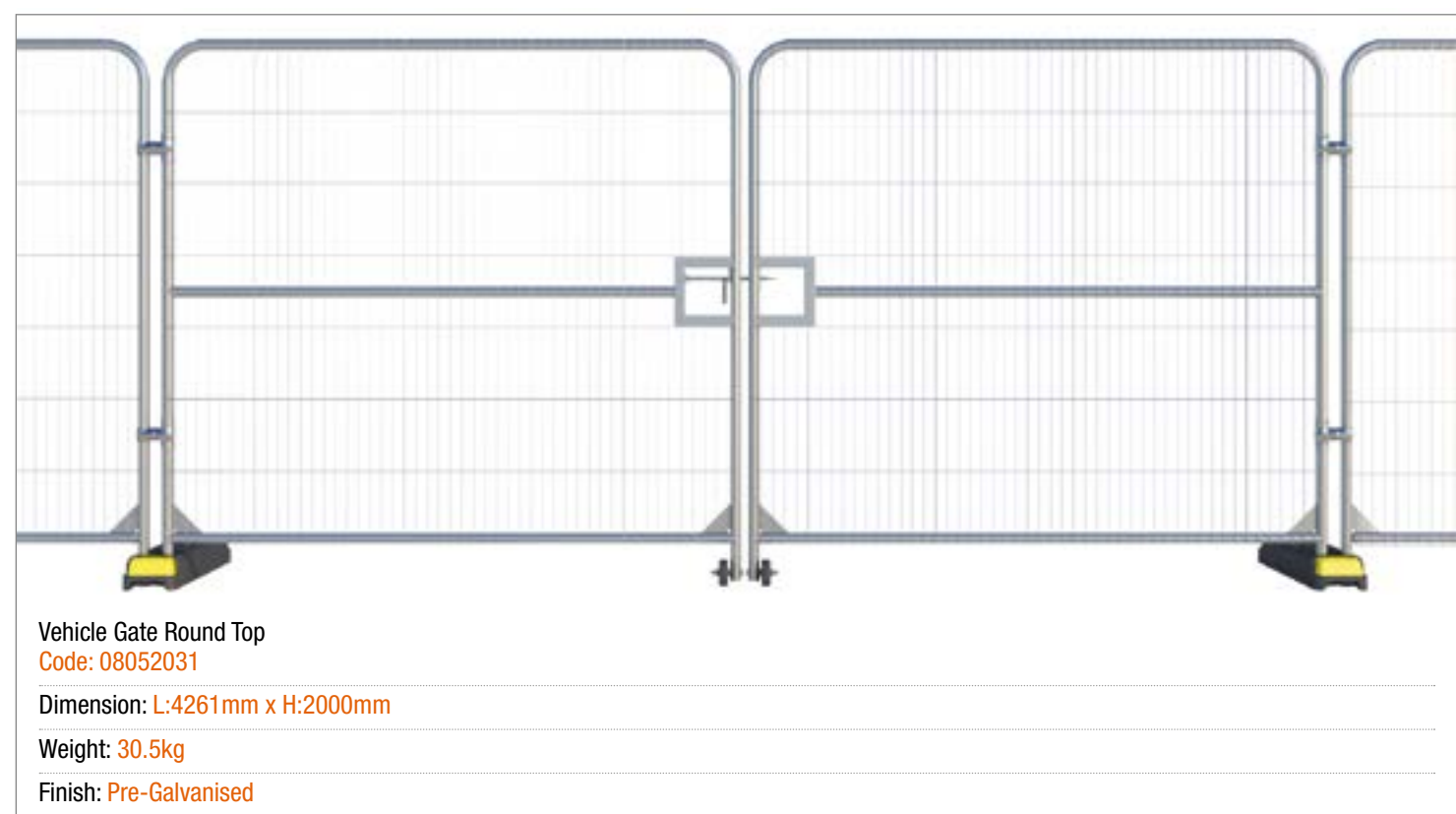

Temporary Fences: Stillages



Temporary Fences: Stillages



Transport Pallet 30 Code: 09055545	Transport Pallet 26 Code: 09055575	Transport Pallet 30 2.2m Code: 09055555
Weight: 95.5kg	Weight: 90.5kg	Weight: 77.2kg
Finish: Post Galvanised	Finish: Post Galvanised	Finish: Post Galvanised
Holds 30 Panels	Holds 26 Panels	Holds 30 Panels

Spreader bars must be used when double stacking Transport Pallet 30/26 full stillages



Transport Pallet 30 Spreader Bar Code: 09055565	Transport Pallet 26 Spreader Bar Code: 09055585
Weight: 7.5kg	Weight: 6.5kg
Finish: Pre-Galvanised	Finish: Pre-Galvanised

Round Top Configuration

Square Top Configuration



Holds 30 Panels

Universal Fence Panel Stillage
Code: 09055531
Weight: 204kg
Finish: Self Coloured

For use with Transport Pallet 30



Transport Block Pallet
Code: 09055587
Weight: 148kg
Finish: Post Galvanised

The ORIGINAL Combi Pallet



Holds 30 Panels and blocks

Transport Pallet KP30
Code: 09055595
Weight: 168.4kg
Finish: Post Galvanised

Temporary Hoarding



We offer a range of both temporary and semi-permanent hoarding options.

Made from steel to ensure strength and durability all of our hoarding products combine quality with a cost-effective solution.

All our hoarding panels can be assembled and dismantled rapidly without the need for specialist tools or skills. Each panel has a galvanised finish as standard and can be customised by colouring with a polyester powder coated finish or adding stripes and decals that can be printed in our in-house print shop.

For your safety and peace of mind, we have a selection of stabilising options to withstand the worst weather conditions and an extensive range of accessories to complement our hoarding system, including:

- Vehicle and pedestrian gates
- Half mesh view panels
- Height extension panels
- Privacy infill panels

Contact us for more information about our bespoke hoarding panels to order.



All our temporary hoarding can be powder coated in a colour of your choice



Many of ZND's products are protected by patents which can be found at www.znduk.com/patents

Temporary Hoarding: Panels

All our Temporary Hoarding panels offer both strength and durability to meet the rigours of construction site use and are complemented with a range of accessories.



Illustration shows Steel Hoarding Panel 2m

Frame	Dimension (mm)	Weight (kg)	Finish	Stock Code
Steel Hoarding Panel 2m	2140 x 1980	25.3	Pre-Galvanised	14151031
Steel Hoarding Panel 2.4m	2140 x 2380	30	Pre-Galvanised	14051230

Temporary Hoarding: Panels



Steel Hoard Panel 1.0m
 Code: 14151051
 Dimension: L:2140mm x H:1000mm
 Weight: 15.2kg
 Finish: Pre-Galvanised

Temporary Hoarding: Gates



Steel Hoard Pedestrian Gate
 Code: 14551030
 Dimension: L:1200mm x H:1980mm
 Weight: 21kg
 Finish: Pre-Galvanised



Steel Hoard Pedestrian Door with Mortice Lock
 Code: 14551540
 Dimension: L:1020mm x H:1980mm
 Weight: 47kg
 Finish: Powder Coated



Steel Hoard Panel Half Mesh
 Code: 14151041
 Dimension: L:2140mm x H:1980mm
 Weight: 21.75kg
 Finish: Pre-Galvanised



Hoarding Stillage
 Code: 17851031
 Weight: 150kg
 Finish: Self Coloured

Holds 30 Panels



Steel Hoard Vehicle Gate
 Code: 15051030
 Dimension: L:4314mm x H:1980mm
 Weight: 53.5kg
 Finish: Pre-Galvanised

Steel Hoard Vehicle Gate 2.4
 Code: 15051040
 Dimension: L:4314mm x H:2380mm
 Weight: 67kg
 Finish: Pre-Galvanised



Pedestrian Barriers

- Fixed Leg Barrier
- Bar Barrier
- Mesh Barrier

Our pedestrian barriers are available in a range of different options, all designed to provide an effective demarcation solution. With robust tubular steel frames, designed safety features combined with our rigorous testing for our barriers to give you the quality and reliability you need.

With a choice of vertical infill tubes or welded mesh, inbuilt or detachable feet, and a high quality galvanised appearance that can be coloured to match your corporate image, we have plenty of options to ensure you're getting the right barrier for the job.

Our most popular barriers are the SmartWeld™ Pedestrian Barrier range which feature:

Fixed legs with swaged feet for safety, which are welded to the frame in an offset position making them ideal for stacking.

The fixed legs are further re-enforced with a **patented** support brace which triangulates the front and rear footing adding strength and protection.

Our barriers have a strong tubular frame with vertical infill tubes and follow the very latest European standards.

Mig Braze welding is used for extra strength and durability and a better long term appearance.

The Euro Mesh Pedestrian Barrier is our most economical form of low-level demarcation. The lightweight barrier is 3.5 metres in length and has a welded mesh infill making it a popular choice for construction site use.

All our barriers can be enhanced with a range of accessories such as corporate labels and advertising covers.



All our pedestrian barriers can be powder coated in a colour of your choice



Many of ZND's products are protected by patents which can be found at www.znduk.com/patents

SmartWeld Fixed Leg Barrier

The Fixed Leg Barrier is our most popular barrier product due to its unique construction that incorporates an integral connection system and fixed legs.



SmartWeld barriers are constructed using the latest braze welding technology that offers improved strength and resistance to corrosion.

Illustration shows Smartweld 2.3 Fixed Leg Barrier

Frame	Dimension (mm)	Frame Ø (mm)	Infill	Weight (kg)	Finish	Stock Code
SmartWeld 2.3 Fixed Leg Barrier	2262 x 1100	38.1	12mm Tube 112mm Aperture	10.6	Pre-Galvanised	01063010
SmartWeld 2.5 Fixed Leg Barrier	2510 x 1100	38.1	12mm Tube 112mm Aperture	11.5	Pre-Galvanised	01065010



Hook and eye



Patented leg strengthening bar



Name plate for corporate logo

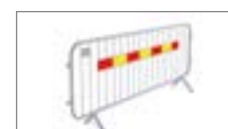

Reflective board



Swaged end safety foot



Non-marking barrier socks

SmartWeld Bar Barrier

The main feature of the Bar Barrier is that it can be used with a variety of feet including flat feet which reduce tripping hazards.



ST30 Euro Barrier

The Euro Mesh Pedestrian Barrier is our most economical form of low-level demarcation. The lightweight barrier is 3.5 metres in length and has a welded mesh infill making it a popular choice for construction site use.



Frame	Dimension (mm)	Frame Ø (mm)	Infill	Weight (kg)	Finish	Stock Code
SmartWeld 2.3 Bar Barrier	2262 x 1100	38.1	12mm Tube 112mm Aperture	9.2	Pre-Galvanised	01062010
SmartWeld 2.5 Bar Barrier	2517 x 1100	38.1	12mm Tube 112mm Aperture	10.1	Pre-Galvanised	01064010

Frame	Dimension (mm)	Frame Ø (mm)	Weight (kg)	Finish	Stock Code
ST30 Euro Barrier	3452 x 1200	40 Vertical 30 Horizontal	10.8	Pre-Galvanised	02061031



Hook and eye



Name plate for corporate logo



Double flat foot



Single flat foot



Concrete & plastic foot



Coupler



Name plate for corporate logo



Double flat foot



Single flat foot



Concrete foot

Fixed Leg Barrier 2.5 HDG (Eco)

This barrier has the convenience of being of single piece construction, it has a frame of 25mm diameter tube that makes it extremely economical to transport between sites.



Frame	Dimension (mm)	Frame Ø (mm)	Infill	Weight (kg)	Finish	Stock Code
Fixed Leg Barrier 2.5 HDG (Eco)	2591 x1100	25	13mm Diameter 111mm Aperture	14.2	Post Galvanised	01065510



Hook and eye



Patented leg strengthening bar

Heavy Duty HDG Barriers

Heavy Duty Post Galvanised Barriers are often used in areas of extreme weather conditions and can be customised with reflective boards to comply with local traffic regulations and standards.



Frame	Dimension (mm)	Frame Ø (mm)	Infill	Weight (kg)	Finish	Stock Code
Fixed Leg Barrier 2.3 HDG	2404 x 1100	38.1	8mm Diameter 115mm Aperture	15	Post Galvanised	01063015
Fixed Leg Barrier 2.3 HDG Reflective Board	2404 x 1100	38.1	8mm Diameter 115mm Aperture	16.5	Post Galvanised	01063020
Bar Barrier 2.3 HDG	2404 x 1100	38.1	8mm Diameter 115mm Aperture	13.7	Post Galvanised	01062490
Bar Barrier 2.3 HDG Reflective Board	2404 x 1100	38.1	8mm Diameter 115mm Aperture	15.2	Post Galvanised	01062500



Hook and eye



Patented leg strengthening bar

Note:
The Bar Barrier 2.3 HDG and Bar Barrier 2.3 HDG Reflective do not come supplied with single flat feet.



Double flat foot



Single flat foot

Pedestrian Barrier: Gates



Pedestrian Barrier: Stillages



Fixed Leg (Walk Through) Barrier
Code: 01057131
Weight: 12.9kg

Dimension: L:2266mm x H:2143mm
Frame diameter: 38.1mm
Finish: Pre-Galvanised & Powder Coated

Fixed Leg (Walk Through c/w Gate) Barrier
Code: 01057141
Weight: 18.7kg

Dimension: L:2266mm x H:2143mm
Frame diameter: 38.1mm
Finish: Pre-Galvanised & Powder Coated

Barrier Stillage 50
Code: 09055431
Weight: 84kg
Finish: Post Galvanised

Holds 50 Barriers

Barrier Stillage 25
Code: 09055441
Weight: 58kg
Finish: Self Coloured

Holds 25 Barriers

Event Barrier Systems



We provide temporary fencing, hoarding and barriers for some of the biggest events in the calendar.

We're trusted by some amazing organisations, who rely on us at short notice to manufacture and deliver large volumes direct to prestigious events such as the London 2012 Olympic Games and the 2014 Glasgow Commonwealth Games and Glastonbury to name a few.



All our event barrier systems can be powder coated in a colour of your choice

Our specialist event products include cycle barriers and police barrier systems.

All our event systems are available fully manufactured, branded and delivered directly to your site.



Many of ZND's products are protected by patents which can be found at www.znduk.com/patents

NEW Cycle Barrier



Cycle Barrier 3m
Code: 02054231

Dimension:
L:3000mm x H:1300mm x W:56mm

Weight: 35kg

Finish: Pre-Galvanised & Powder Coated



Cycle Barrier Foot
Code: 13057230

Dimension:
L:861mm x H:191mm x W:150mm

Weight: 12.9kg

Finish: Pre-Galvanised & Powder Coated



Cycle Barrier Stillage
Code: 09056231

Dimension:
L:3232mm x H:1600mm x W:1200mm

Weight: 148kg

Finish: Pre-Galvanised & Powder Coated

Holds 20 Barriers

Please note, all dimensions and weights are correct at the time of print, however they are subject to change. Please refer to the customer portal for the latest information.

Police Barrier



Police Barrier 1.5m
Code: 02055031
Dimension: L:1526mm x H:1065mm x W:705mm
Frame: 33.7mm diameter
Infill: 3.9mm dia Wire 50mm Aperture
Weight: 26kg
Finish: Post Galvanised



Police Barrier Gate HD (5ft)
Code: 02055091
Dimension: L:1602mm x H:1106mm
Frame: 33.7mm diameter
Infill: 3.9mm dia Wire 50mm Aperture
Weight: 22kg
Finish: Post Galvanised

Police Barrier Gate HD (8ft)
Code: 02055151
Dimension: L:3052mm x H:1106mm
Frame: 33.7mm diameter
Infill: 3.9mm dia Wire 50mm Aperture
Weight: 33.5kg
Finish: Post Galvanised



Police Barrier – Stillage
Code: 02055231
Weight: 46kg
Finish: Post Galvanised

Holds 30 Barriers



Police Barrier Gate – Stillage
Code: 02055235
Weight: 115kg
Finish: Post Galvanised

Holds 20 Gates

Police Barriers Euro



Police Barrier Collapsible
Code: 02055240
Dimension: L:2187mm x H:1090mm x W:1004mm
Frame dia: 33.7mm
Weight: 48.5kg
Finish: Post Galvanised

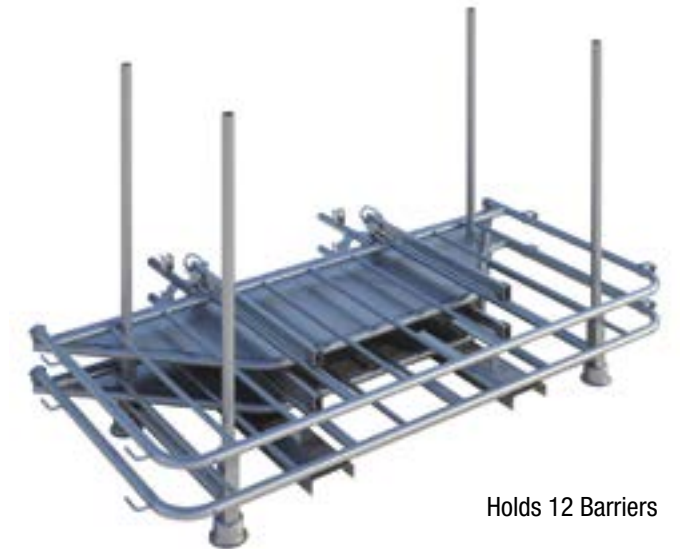

Holds 12 Barriers

Police Barrier Collapsible Stillage
Code: 02055245
Weight: 28kg
Finish: Post Galvanised



Police Barrier Stiff
Code: 02055250
Dimension: L:2100mm x H:1110mm x W:937mm
Weight: 39kg
Finish: Post Galvanised

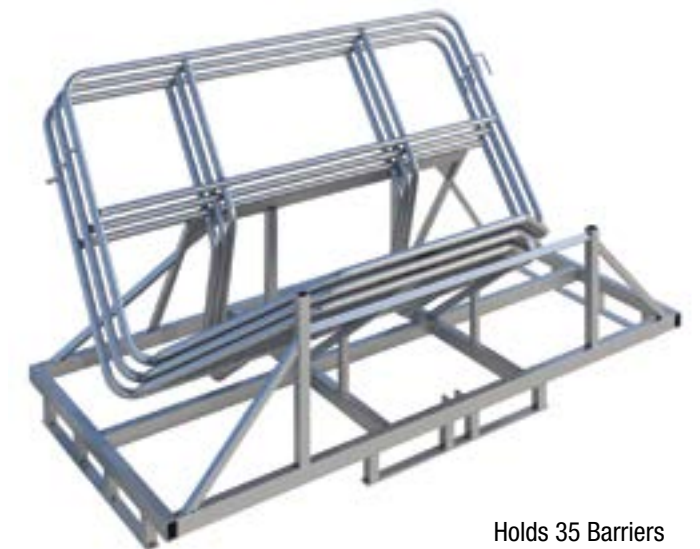

Holds 35 Barriers

Police Barrier Stiff Stillage
Code: 02055255
Weight: 100kg
Finish: Post Galvanised

Stabiliser Systems



Thanks to our wide array of stabilising products, assembling a run of fencing, hoarding and ensuring they stay up, whatever the weather, is now easy and straightforward.

Designed and developed for use in a range of environmental conditions, sites, surfaces and locations, our stabilisers help you maintain the highest standards of health and safety.

To help ensure you get the correct stabilising system for your run of fences, hoarding or barriers we maintain a Customer Portal where our valued customers can access our assembly guides as well as our unique Wind Resistance Calculator which provides performance information on each and every stabilising option and panel, backed up by detailed structural calculations.

We are also available to provide advice and guidance for your particular site requirement.

Key to product categories

- F Fencing
- H Hoarding
- B Barriers

For details of kentledge blocks, couplers and anti-lift brackets used in the following stabiliser systems please see the Accessories section on page 38. Anti-lift devices must be used in conjunction with all suggested stabilising methods.



This image shows the HSG151 stabiliser and block cradle in use.

Many of ZND's products are protected by patents which can be found at www.znduk.com/patents

Stabiliser Systems



Fence Stabiliser Code
F Fence Stabiliser 09551530
 Finish: Pre-Galvanised See page 36-37 for details of stabiliser components.



Fence Stabiliser and Cross Brace Code
F Fence Stabiliser 09551530
F Fence Stabiliser Brace 09551535
 Finish: Pre-Galvanised See page 36-37 for details of stabiliser components.



Fence Stabiliser with Brace Code
F Fence Stabiliser with Cross Brace 09551538
 Finish: Pre-Galvanised See page 36-37 for details of stabiliser components.



Zero-Trip Base and Cranked Stabiliser Code
F H Zero-Trip Cranked Stabiliser 09551740
F H Zero-Trip Stabiliser Base 09551750
 Finish: Pre-Galvanised See page 36-37 for details of stabiliser components.



Fence Stabiliser (HSG151) Small Code
F Fence Stabiliser (HSG151) Small 09551730
 Finish: Pre-Galvanised See page 36-37 for details of stabiliser components.



Stabiliser with Plate for Ground Pin Code
F Fence Stabiliser with Plate – Euro 095515381
F Ground Pin – Euro 0955931
 Finish: Pre-Galvanised See page 36-37 for details of stabiliser components.

Stabiliser Systems



Stabiliser with Plate & Spigot Code

F H	Stabiliser with Plate & Spigot - Euro	095515382
F	Ground Pin - Euro	0955931

Finish: **Post Galvanised** See page 36-37 for details of stabiliser components.

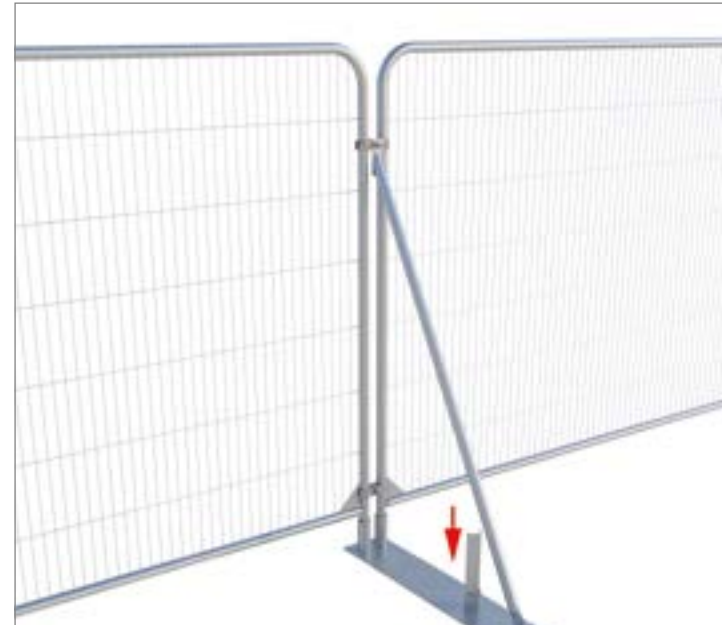

Fence Stabiliser c/w Large Plate - Euro Code

F H	Folding Stabiliser - Euro	095515383
F	Ground Pin - Euro	0955931

Finish: **Post Galvanised** See page 36-37 for details of stabiliser components.



Hoarding Stabiliser and Cross Brace with Block Tray Code

F H	Hoarding Stabiliser	16552031
F H	Hoarding Stabiliser Brace	16552051
F H	Hoarding Block Tray Rear	16551530

Finish: **Pre-Galvanised** See page 36-37 for details of stabiliser components.



Hoarding Stabiliser with Brace and Block Tray Code

F H	Hoarding Stabiliser with Cross Brace	16552075
F H	Hoarding Block Tray Rear	16551530

Finish: **Pre-Galvanised** See page 36-37 for details of stabiliser components.

Stabiliser Systems



Big Foot Stabiliser Code

F H	Big Foot Block Tray	16552110
F H	Big Foot Tubular Spigot Base	16552111
F H	Big Foot Stabiliser HD	16552117

Finish: **Pre-Galvanised** See page 36-37 for details of stabiliser components.



Big Foot Stabiliser - Reduced Footprint Code

F H	Big Foot Block Tray	16552110
F H	Windbreaker Zero - Trip Foot	16552096
F H	Windbreaker Bottom Stabiliser - Reduced Footprint	16552099

Finish: **Pre-Galvanised** See page 36-37 for details of stabiliser components.

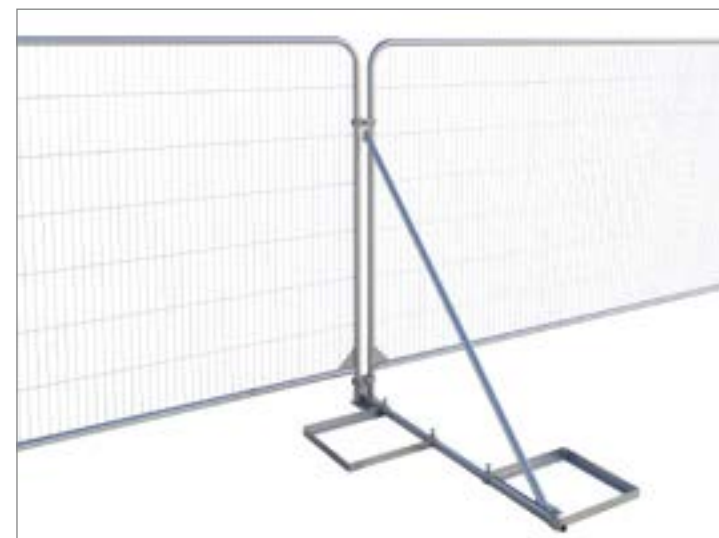

Windbreaker Stabiliser Code

F H	Windbreaker Zero - Trip Foot	16552096
F H	Windbreaker Bottom Tube	16552097
F H	Windbreaker Block Tray	16552100
F H	Hoarding Stabiliser	16552031

Finish: **Pre-Galvanised** See page 36-37 for details of stabiliser components.















Windbreaker Stabiliser - Reduced Footprint Code













F H	Windbreaker Zero - Trip Foot	16552096
F H	Windbreaker Bottom Tube - Reduced Footprint	16552098
F H	Windbreaker Block Tray	16552100
F H	Windbreaker Bottom Stabiliser - Reduced Footprint	16552099

Finish: **Pre-Galvanised** See page 36-37 for details of stabiliser components.

Stabiliser Components

 <p>F Fence Stabiliser Code: 09551530 Weight: 2.5kg Finish: Pre-Galvanised</p>	 <p>F Fence Stabiliser Brace Code: 09551535 Weight: 1.45kg Finish: Pre-Galvanised</p>	 <p>F Fence Stabiliser with Cross Brace Code: 09551538 Weight: 3.5kg Finish: Pre-Galvanised</p>	 <p>F H Zero-Trip Cranked Stabiliser Code: 09551740 Weight: 3kg Finish: Pre-Galvanised</p>
 <p>F H Zero-Trip Stabiliser Base Code: 09551750 Weight: 3.8kg Finish: Electro Galvanised</p>	 <p>F Fence Stabiliser (HSG151) Small Code: 09551730 Weight: 1.75kg Finish: Pre-Galvanised</p>	 <p>F H Hoarding Stabiliser Code: 16552031 Weight: 3.2kg Finish: Pre-Galvanised</p>	 <p>F H Hoarding Stabiliser Brace Code: 16552051 Weight: 1.75kg Finish: Pre-Galvanised</p>
 <p>F H Hoarding Stabiliser with Cross Brace Code: 16552075 Weight: 4.5kg Finish: Pre-Galvanised</p>	 <p>F Euro Stabiliser Code: 095515381 Weight: 3.9kg Finish: Post Galvanised</p>	 <p>F Euro Spigot Stabiliser Code: 095515382 Weight: 4.4kg Finish: Post Galvanised</p>	 <p>F H Euro Folding Stabiliser Code: 095515383 Weight: 14kg Finish: Post Galvanised</p>

Stabiliser Components

 <p>F H Ground Pin - Euro Code: 0955931 Weight: 2.1kg Finish: Electro Galvanised</p>	 <p>F H Hoarding Block Tray Rear Code: 16551530 Weight: 2.7kg Finish: Electro Galvanised</p>	 <p>F H Windbreaker Zero-Trip Foot Code: 16552096 Weight: 1.4kg Finish: Electro Galvanised</p>	 <p>F H Windbreaker Bottom Tube Code: 16552097 Weight: 2.1kg Finish: Pre-Galvanised</p>
 <p>F H Windbreaker Bottom Tube - Reduced Footprint Code: 16552098 Weight: 0.9kg Finish: Pre-Galvanised</p>	 <p>F H Windbreaker Block Tray Code: 16552100 Weight: 3.3kg Finish: Electro Galvanised</p>	 <p>F H Windbreaker Bottom Stabiliser - Reduced Footprint Code: 16552099 Weight: 2.7kg Finish: Pre-Galvanised</p>	 <p>F H B Stabiliser Pin Code: 09552030 Weight: 0.12kg Finish: Pre-Galvanised</p>
 <p>F H B Stabiliser Pin HD Code: 09552230 Weight: 0.45kg Finish: Electro Galvanised</p>	 <p>F H Big Foot Block Tray Code: 16552110 Weight: 8kg Finish: Electro Galvanised</p>	 <p>F H Big Foot Tubular Spigot Base Code: 16552111 Weight: 2.1kg Finish: Electro Galvanised</p>	 <p>F H Big Foot Stabiliser HD Code: 16552117 Weight: 3.1kg Finish: Pre-Galvanised</p>

Accessories

Our accessories are designed and rigorously tested to work in harmony with our fencing, hoarding and barrier products and include:

- Fence feet
- Couplers
- Lights
- Spanners

All of our accessories are designed to enhance our fencing, hoarding and barriers to not only make sure that they are safe but also secure.

The letter from the key below indicates the accessory most compatible with a product.

Key to product categories

- F** Fencing
- H** Hoarding
- B** Barriers

We can also create bespoke accessories for all your needs. Please contact us for more information.



Many of ZND's products are protected by patents which can be found at www.znduk.com/patents

Accessories



F H B
Concrete Fence Foot
 Code: 12051030
 Weight: 28kg
 Finish: Self Coloured



F H B
Concrete Fence Foot - Euro
 Code: 12051035
 Weight: 32kg
 Finish: Self Coloured



F H B
Thermo-Plastic Foot (std) Hi Vis
 Code: 12551030
 Weight: 15kg
 Finish: Self Coloured



F H B
Thermo-Plastic Foot - Euro
 Code: 12551040
 Weight: 26kg
 Finish: Self Coloured



F B
Octagonal Thermo-Plastic Base
 Code: 12551038
 Weight: 26kg
 Finish: Self Coloured

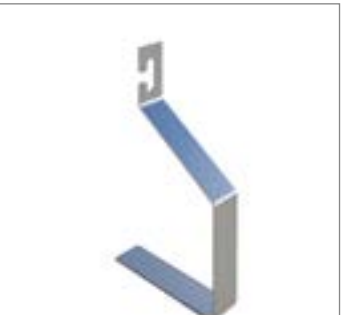

F H B
Anti-lift Bracket
 Code: 09051030
 Weight: 0.4kg
 Finish: Electro Galvanised



F H B
Anti-lift Bracket - Euro
 Code: 09051035
 Weight: 1kg
 Finish: Electro Galvanised



F H
Block Retaining Bracket - Galv
 Code: 16051530
 Weight: 0.9kg
 Finish: Pre-Galvanised



F H
Block Cradle
 Code: 13057240
 Weight: 3.3kg
 Finish: Electro Galvanised



B
Barrier Ballast Block
 Code: 12551531
 Weight: 16kg
 Finish: Self Coloured















F H
Big Foot 390 Kentledge Block
 Code: 16552105
 Weight: 390kg
 Finish: Self Coloured















F H
Big Foot 780 Kentledge Block
 Code: 16552103
 Weight: 780kg
 Finish: Self Coloured

Accessories

 <p>NEW</p> <p>*Used in pairs</p> <p>F Slot Block 1.75m – Red Code: 12551533</p> <p>Weight: 14kg (When Empty) Finish: Self Coloured</p>	 <p>NEW</p> <p>*Used in pairs</p> <p>F Slot Block 1.75m – White Code: 12551534</p> <p>Weight: 14kg (When Empty) Finish: Self Coloured</p>	 <p>NEW</p> <p>*Used in pairs</p> <p>F Slot Block 1.75m – Yellow Code: 12551535</p> <p>Weight: 14kg (When Empty) Finish: Self Coloured</p>	 <p>B Double Flat Metal Foot Female Galv Code: 13052530</p> <p>Weight: 1.8kg Finish: Pre-Galvanised</p>
 <p>F H B Double Flat Foot Small – Euro Code: 13052540</p> <p>Weight: 1.3kg Finish: Post Galvanised</p>	 <p>F H B Large Foot Plate – Euro Code: 13052550</p> <p>Weight: 12.5kg Finish: Post Galvanised</p>	 <p>B Single Flat Foot Code: 13053530</p> <p>Weight: 2.1kg Finish: Post Galvanised</p>	 <p>F H B Ground Pin Double Tube Foot – Euro Code: 12551540</p> <p>Weight: 3kg Finish: Electro Galvanised</p>
 <p>F H B Tube Fence Foot Stand Code: 12551550</p> <p>Weight: 5.7kg Finish: Post Galvanised</p>	 <p>B Sloping Barrier Foot – Euro Code: 13053540</p> <p>Weight: 2.2kg Finish: Electro Galvanised</p>	 <p>F H Panel Mounting Wall Bracket Code: 08552580</p> <p>Weight: 0.63kg Finish: Electro Galvanised</p>	 <p>B Plastic Sock for Fixed Leg Barrier Code: 19551230</p> <p>Weight: N/A Finish: Self Coloured</p>

Accessories

 <p>F H B Fence Coupler Code: 08551030</p> <p>Weight: 0.28kg Finish: Pre-Galvanised</p>	 <p>F B Gripper Coupler Lite Code: 08551300</p> <p>Weight: 0.22kg Finish: Electro Galvanised</p>	 <p>F H B Heavy Duty Fence Coupler (Gripper) Code: 08551330</p> <p>Weight: 0.4kg Finish: Electro Galvanised</p>	 <p>F H B Heavy Duty Lockable Coupler (Griplock) Code: 08551430</p> <p>Weight: 0.4kg Finish: Electro Galvanised</p>
 <p>F H B Fence Coupler – Euro Code: 08551040</p> <p>Weight: 0.3kg Finish: Post Galvanised</p>	 <p>F H B Lockable Coupler – Euro Code: 08551435</p> <p>Weight: 0.3kg Finish: Post Galvanised</p>	 <p>F H B Fence Coupler HD – Euro Code: 08551050</p> <p>Weight: 0.9kg Finish: Post Galvanised</p>	 <p>F H Scaffold 2 Hoard Coupler Code: 17852531</p> <p>Weight: 0.75kg Finish: Electro Galvanised</p>
 <p>F H Lockable Gate Hinge Coupler Code: 09054080</p> <p>Weight: 0.6kg Finish: Electro Galvanised</p>	 <p>F H In Ground Scaffold 2 Fence Coupler Code: 08551437</p> <p>Weight: 0.9kg Finish: Electro Galvanised</p>	 <p>F H B Coupler Spanner Code: 08551440</p> <p>Weight: 0.5kg Finish: Hard Chrome</p>	 <p>F H B Lockable Coupler Spanner Socket Code: 08551450</p> <p>Weight: 0.1kg Finish: Hard Chrome</p>

Accessories



F
Gate Hinge Galv
Code: 09054030
Weight: 1.2kg
Finish: Post Galvanised



F
Pedestrian Gate Ring
Code: 07553061
Weight: 0.35kg
Finish: Electro Galvanised



F H
Castor Assembly Large – Euro
Code: 09053025
Weight: 0.8kg
Finish: Electro Galvanised



F H
Castor Wheel Assembly
Code: 09052520
Weight: 0.5kg
Finish: Pre-Galvanised



F
Fence Label (196x80)
Code: 0551631
Weight: 0.04kg
Finish: Printed



F
Fence Label (272x100)
Code: 0551634
Weight: 0.07kg
Finish: Printed



H B
Barrier Adhesive Label
Code: 0551635
Weight: N/A
Finish: Printed



F H
Panel Hook & Eye
Code: 030551235
Weight: 0.1kg
Finish: Electro Galvanised



F
Anti-Climb Extension Panel Galv
Code: 09251531
Weight: 8.4kg
Finish: Pre-Galvanised



F
Fence Panel Pedestrian Handrail
Code: 09052245
Weight: 3.7kg
Finish: Pre-Galvanised



F H
Female Gate Post for Pedestrian Gate
Code: 08053031
Weight: 1.8kg
Finish: Pre-Galvanised



F
Gantry Entrance Panel*
Code: 08052081
Weight: 24.7kg
Finish: Pre-Galvanised

* Available with signage.

Accessories



F B
Reflective Board (Metal) Red-White
Code: 02251420
Weight: 2kg
Finish: Pre-Galvanised



F B
Reflective Board (Metal) Red-Yellow
Code: 02251425
Weight: 2kg
Finish: Pre-Galvanised



F
Reflective Fence Strip (PVC) 3.5m (Red-White)
Code: 02251430
Weight: 0.5kg
Finish: Self Coloured



F
Reflective Fence Strip (PVC) 3.5m (Red-Yellow)
Code: 02251435
Weight: 0.5kg
Finish: Self Coloured



H
Steel Hoarding Panel Extension
Code: 15551530
Weight: 6.5kg
Finish: Pre-Galvanised



F H
Cable Containment J Hook
Code: 09052255
Weight: 3kg
Finish: Pre-Galvanised



F H
Cable Containment J Hook Foot
Code: 09052260
Weight: 1.9kg
Finish: Pre-Galvanised



F H B
Multilite
Code: 32651010
Weight: 1.25kg
Finish: Electro Galvanised



H
Hoarding Filler Plate 2m
Code: 17051030
Weight: 2.1kg
Finish: Pre-Galvanised



H
Hoarding Filler Plate 2.4m with Leg
Code: 17051540
Weight: 2.4kg
Finish: Pre-Galvanised



H
Hoarding Filler Plate 2.4m without Leg
Code: 17051550
Weight: 2.7kg
Finish: Pre-Galvanised



H
Hoarding Anti-crawl Skirt Galvanised
Code: 17551030
Weight: 2.5kg
Finish: Pre-Galvanised

Accessories



H
 Profiled Sheets (Stripes)
 0.5mm x 150mm
 Code: 18551110
 Weight: 2.1kg
 Finish: Pre-Galvanised



F H
 Barbed Wire Extension (Square Panel)
 Code: 09052030
 Weight: 0.6kg
 Finish: Electro Galvanised



F
 Barbed Wire Extension (Round Top Panel)
 Code: 09052230
 Weight: 0.5kg
 Finish: Electro Galvanised



F
 Barbed Wire Extension Y Shape
 Code: 09052235
 Weight: 1.4kg
 Finish: Electro Galvanised

New Product
 Emergency Exit Gate
 Code: 08052051 Weight: 43kg



Please see the website for more details www.znduk.com

Accessories: Netting & Covers



- 1 Tennis Net Green
- 2 Fence Cover Green
- 3 Acoustic Fence Cover
- 4 Printed Banner

Fence Covers		Weight	Acoustic Covers		Weight
0956001	Fence Cover Black 3.5 x 1.76	1kg	0956031	Acoustic Fence Cover 1.2 x 2.0	6kg
0956011	Fence Cover Black 3.5 x 1.76 (FR)	1kg	0956041	Acoustic Fence Cover 1.8 x 2.0	9kg
0955971	Fence Cover White 3.5 x 1.76	1kg	0956045	Acoustic Fence Cover 'S' Clip 13	73g
0955981	Fence Cover White 3.5 x 1.76 (FR)	1kg	0956046	Acoustic Fence Cover 'S' Clip 20	112g
0955951	Fence Cover Blue 3.5 x 1.76	1kg	Printed Banners		Weight
0955955	Fence Cover Blue 3.5 x 1.76 (FR)	1kg	0956051	Printed Banner Solid 3.5 x 1.8	2.7kg
0955961	Fence Cover Green 3.5 x 1.76	1kg	0956061	Printed Banner Mesh 3.5 x 1.8	2.4kg
0955965	Fence Cover Green 3.5 x 1.76 (FR)	1kg	Netting		Weight
			0955941	Tennis Net Green 50 x 1.8	13.5kg

For more information about printing your company details onto banners and covers, go to the ZND Print Services section on page 50 or go to www.znduk.com/print

Site Safety

We supply a wide range of site safety equipment to meet our customers' needs. You'll find our high quality standards and our service just as reliable as our fencing, hoarding and barrier products.



Many of ZND's products are protected by patents which can be found at www.znduk.com/patents

Scaffold Products

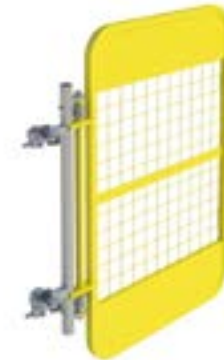

Ladder Access Gate (Spring Return)
Code: 27051931
Weight: 11kg
Finish: Electro Galvanised & Powder Coated



Pin with Wire
Code: 27365090
Weight: 0.05kg
Finish: Electro Galvanised



Scaffold Bin
Code: 09055731
Weight: 62kg
Finish: Pre-Galvanised



Scaffold Stillage
Code: 09055631
Weight: 30.8kg
Finish: Pre-Galvanised



No.1 Builders Trestle (Painted) Round
Code: 27360231
Weight: 7.2kg
Finish: Powder Coated



No.2 Builders Trestle (Painted) Round
Code: 27360731
Weight: 9.1kg
Finish: Powder Coated



No.3 Builders Trestle (Painted) Round
Code: 27361231
Weight: 10.5kg
Finish: Powder Coated

Smartguard Trestle Handrail System



Smartguard Hand Rail System



Smartguard Access Gate
Code: 27364731
Weight: 8.7kg
Finish: Powder Coated



Smartguard Post
Code: 27362031
Weight: 3.5kg
Finish: Powder Coated



Smartguard Stabiliser
Code: 27364531
Weight: 3.7kg
Finish: Powder Coated



Smartguard Handrail
Code: 27362531
Weight: 1.2kg
Finish: Powder Coated



Smartguard End Handrail
Code: 27363031
Weight: 1.3kg
Finish: Powder Coated



Smartguard Ladder Access Bracket
Code: 27364631
Weight: 3kg
Finish: Powder Coated



Smartguard Panel
Code: 27363531
Weight: 8.3kg
Finish: Powder Coated

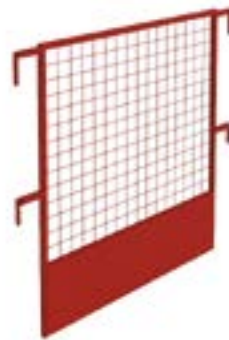

Smartguard End Panel
Code: 27364031
Weight: 8.3kg
Finish: Powder Coated

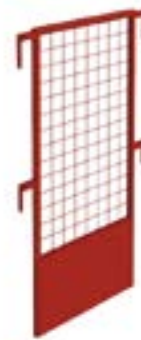

Smartguard Half Panel
Code: 27363631
Weight: 6kg
Finish: Powder Coated



Smartguard Bridging Deck
Code: 27364831
Weight: 6.7kg
Finish: Powder Coated



Smartguard Return Bridging Deck
Code: 27364832
Weight: 5.8kg
Finish: Powder Coated



Smartguard Return Pins
Code: 27365032
Weight: 1.1kg
Finish: Powder Coated



ZND Print Services

All in one solution:
Manufactured, branded and delivered.

To ensure our customers get the best possible experience we now offer a convenient in-house printing solution providing fencing, hoarding and barrier products that are manufactured, branded, delivered and ready to use.

We can manage all post-manufacture print installation, from basic labelling to full banner coverings and using the latest techniques in UV printing technology we can provide printed products that are:

We can also provide a wide range of printable media on which to place your print including:

- Diabond
- PVC foam board
- PVC banner material
- PVC mesh
- Paper
- Vinyl
- Bubble board
- Sheet aluminum

 Scratch resistant

 Waterproof

 Colour consistent

 Fade resistant

To find out more about our UK based print room and how it could help your business, please visit www.znduk.com/print and watch our video.





We're proud to be associated with some of the most high profile events around the world, including the London 2012 Olympic Games. Our enormous in-house capacity to manufacture panels means most of our products can be made to meet very short timescales.

We are committed to finding ways of improving our existing products and services and strive to offer products that provide better performance, strength and safety, whilst controlling costs to offer our customers the best possible value.

Fresh thinking helps us to create new products and bring more choice into the markets we serve.

Please do not hesitate to get in touch with us if you have any questions about our service or products.

ZNDUK

Distributor details:

Head Office:

ZND UK Limited

The Gateway
Parkgate
Rotherham
South Yorkshire
S62 6JL

Manufacturing:

ZND UK Limited

Mangham Road
Barbot Hall Ind. Est.
Rotherham
South Yorkshire
S61 4RJ

Sales Offices:



UK

T: +44 (0)1709 521100

F: +44 (0)1709 521111

E: sales@znduk.com



FR

T: +33 (0)2 99 55 50 35

F: +33 (0)2 99 55 37 33

E: sales@zndfr.com



DE

T: +49 (0)2119 5989466

F: +49 (0)2119 5989477

E: info@zndde.com



NL

T: +31 (0)40-2014812

F: +31 (0)40-2014831

E: info@znddraad.com



CE

T: +48 (0)77 401 90 18

F: +48 (0)77 457 77 05

E: biuro@zndce.com